

Spike Tip

PT-1000 Temperature Probe

Reads	Temperature
Probe type	Class B platinum, RTD
Range	-50°C to 200°C
Accuracy	+/- (0.3 + (0.005*t))
Reaction time	90% in 10s
Body	Stainless Steel 304
Cable length	1m (3.2')
Cable material	Teflon
Connector	Male SMA
Output	Resistance (Analog)
Life expectancy	15 years

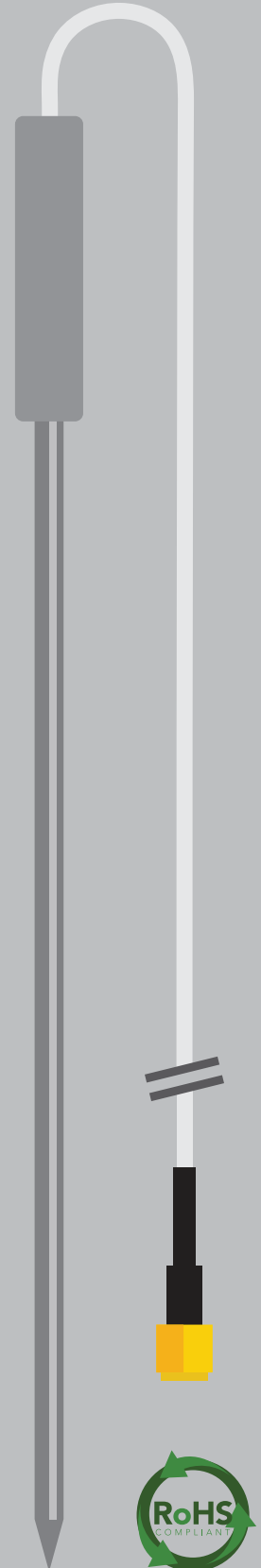

Measurements

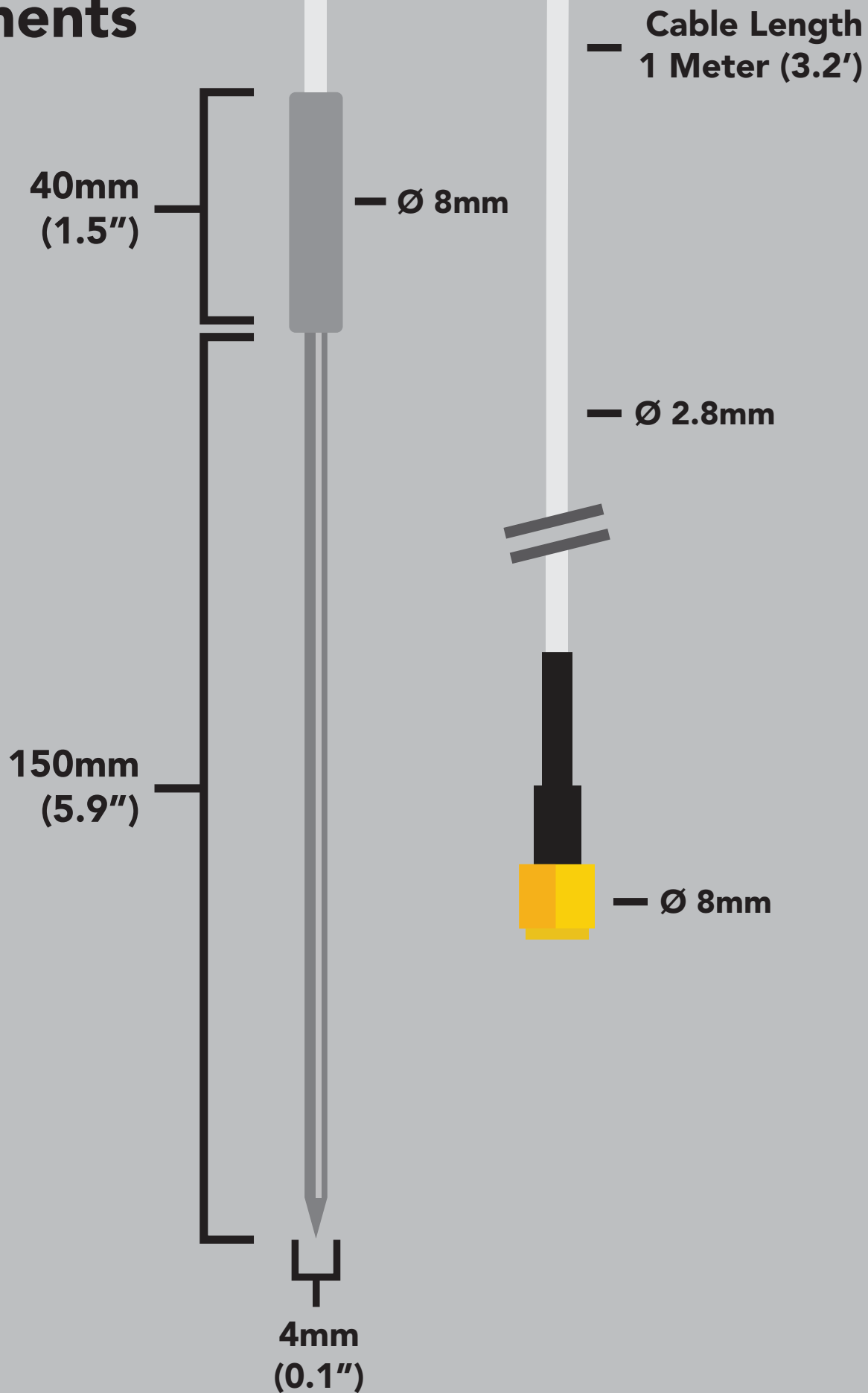

Specifications

Cable length	1 Meter (3.2')
Weight	36.8 grams
Min cable temp	-50°C
Max cable temp	200°C
Sensing material	Platinum
Dimensions	4mm x 1m (0.1" x 38.4")
SMA connector	Male
Sterilization	Chemical / Autoclave
Food safe	Yes

Materials

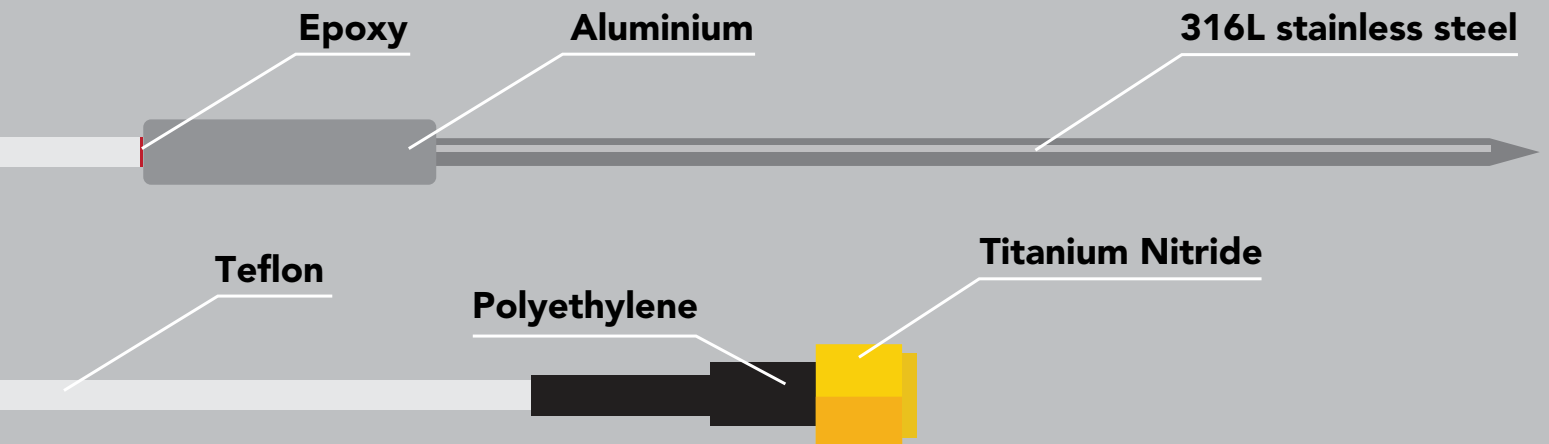

This Temperature probe can be **fully submerged** in fresh or salt water, up to the SMA connector **indefinitely**.

Typical Applications

- Sturdy design with spike tip for food and soil applications
- Hydroponics / aquaponics
- Beer, wine and other liquor

NSF/ANSI 51 Compliant

Food Safe

Atlas Scientific LLC, hereby certifies that,

Spike Tip PT-1000 Temperature Probe
Part # **PT-SPIKE**

Complies with NSF/ANSI Standard 51

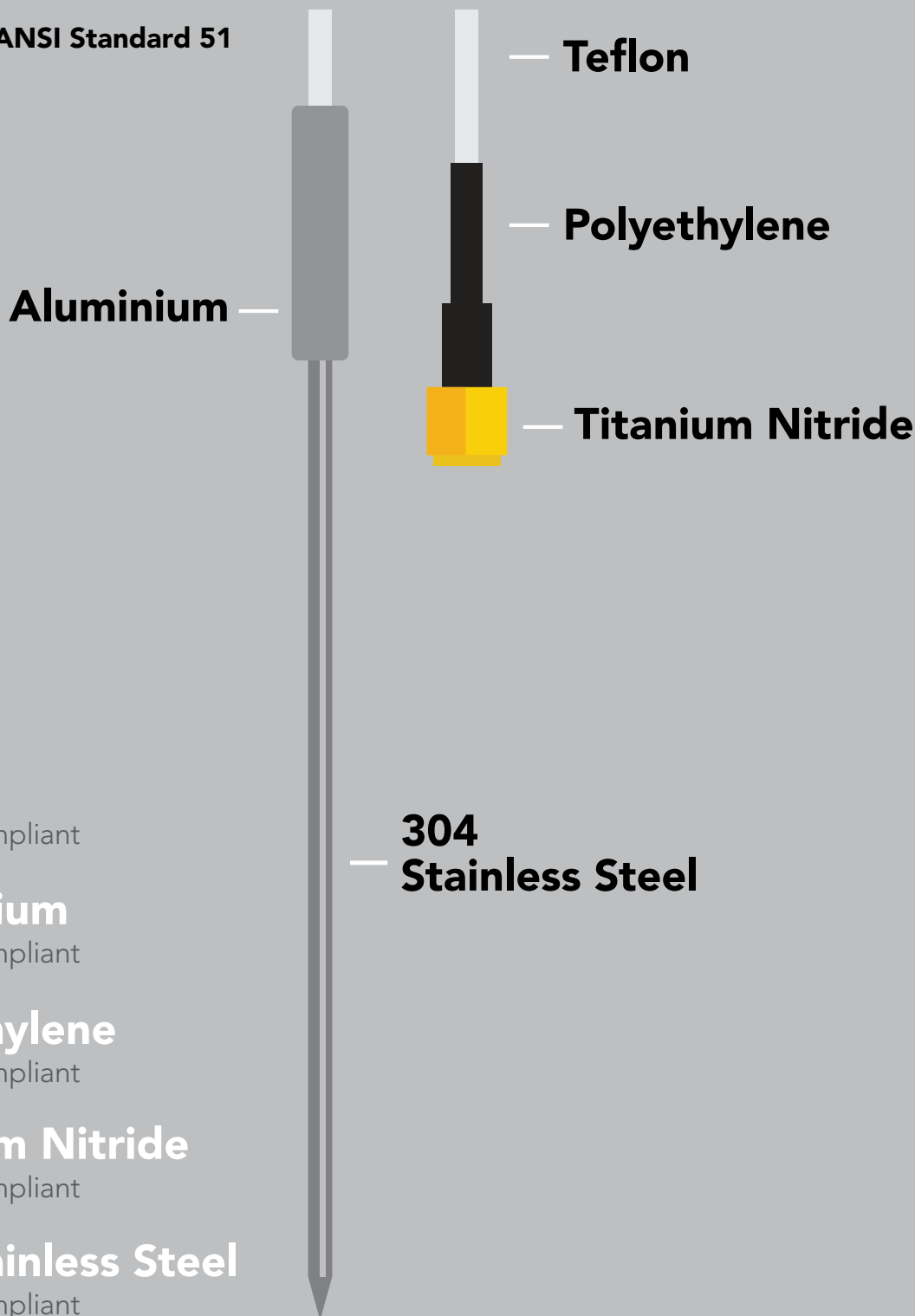

Teflon

NSF-51 Compliant



Aluminium

NSF-51 Compliant



Polyethylene

NSF-51 Compliant



Titanium Nitride

NSF-51 Compliant



304 Stainless Steel

NSF-51 Compliant

Operating principle

Unlike any other material, platinum's correlation between resistance and temperature seems to be woven into the fabric of the universe. It is for this reason, that the platinum RTD temperature sensor is the industrial standard for temperature measurement.

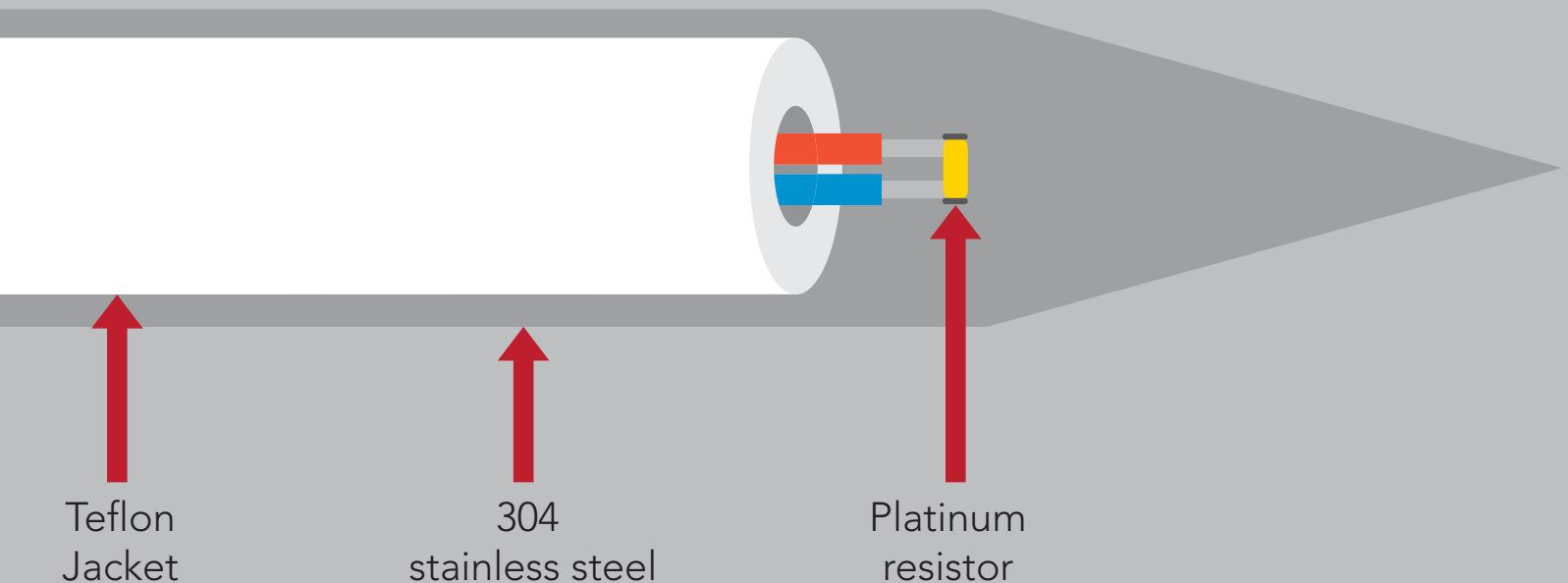
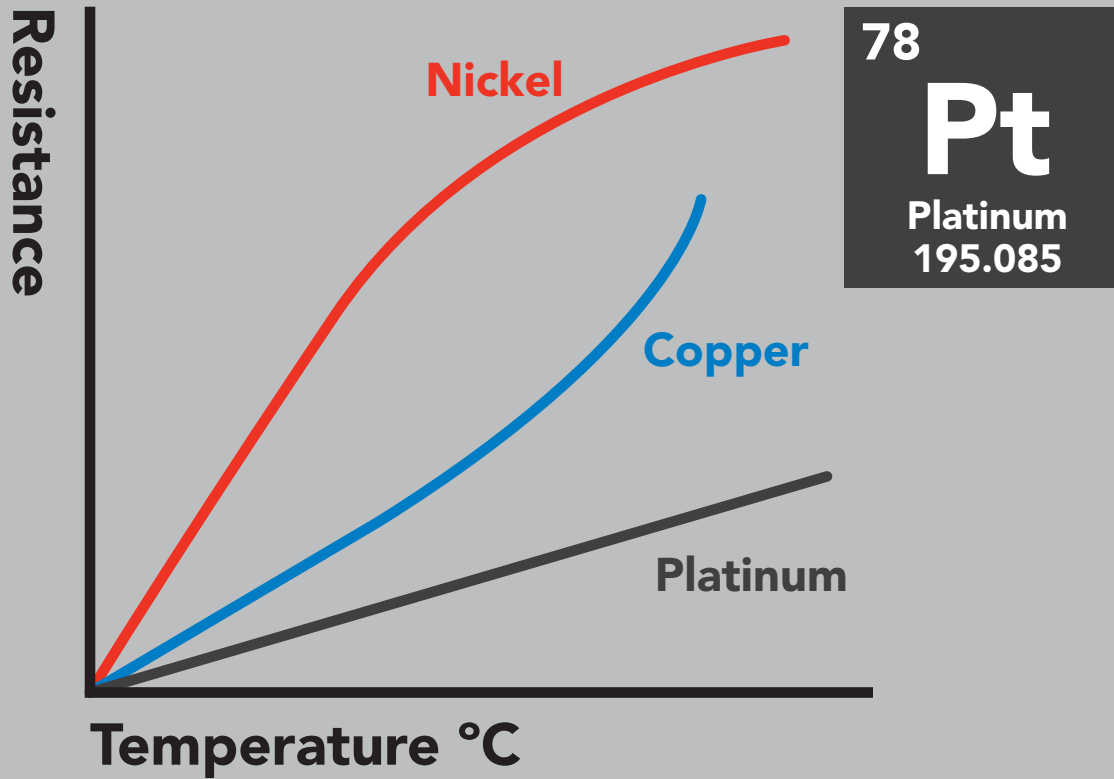

The PT-1000 temperature probe is a resistance type thermometer. Where PT stands for platinum and 1000 is the measured resistance of the probe at 0°C in ohms (1k at 0°C). As the temperature changes the resistance of the platinum changes.

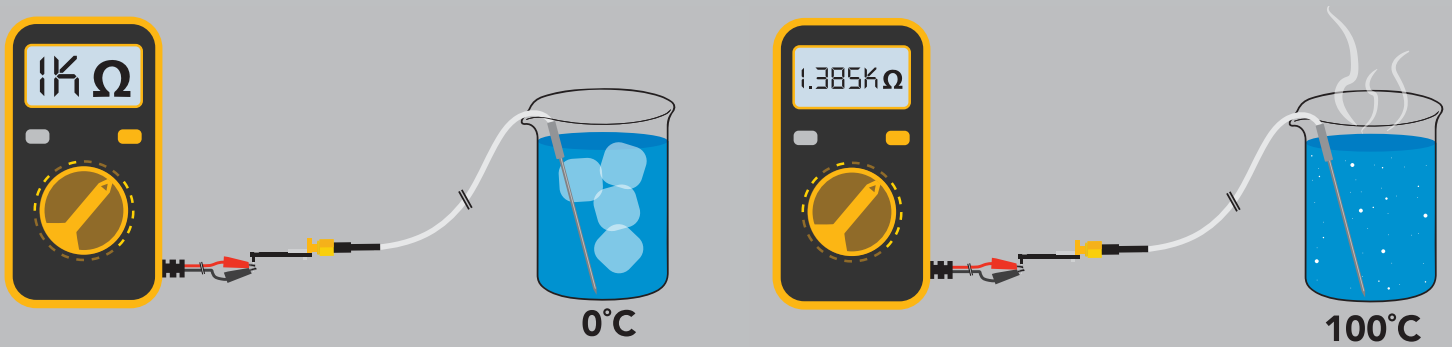

To convert the resistance of the probe to temperature, use the following simplified equation:

$$T = - \frac{\sqrt{(-0.00232(R) + 17.59246)} - 3.908}{0.00116}$$

T = Degrees Celsius

R = Resistance measured from PT-1000 temperature probe

Below is a small table of temperatures and resistances, to help insure the above equation has been properly embedded into your code.

°C	Ω	°C	Ω	°C	Ω
-10	= 960.9	7	= 1027.3	24	= 1093.5
-9	= 964.8	8	= 1031.2	25	= 1097.3
-8	= 968.7	9	= 1035.1	26	= 1101.2
-7	= 972.6	10	= 1039	27	= 1105.1
-6	= 976.5	11	= 1042.9	28	= 1109
-5	= 980.4	12	= 1046.8	29	= 1112.8
-4	= 984.4	13	= 1050.7	30	= 1116.7
-3	= 988.3	14	= 1054.6	31	= 1120.6
-2	= 992.2	15	= 1058.5	32	= 1124.5
-1	= 996.1	16	= 1062.4	33	= 1128.3
0	= 1000	17	= 1066.3	34	= 1132.2
1	= 1003.9	18	= 1070.2	35	= 1136.1
2	= 1007.8	19	= 1074	36	= 1139.9
3	= 1011.7	20	= 1077.9	37	= 1143.8
4	= 1015.6	21	= 1081.8	38	= 1147.7
5	= 1019.5	22	= 1085.7	39	= 1151.5
6	= 1023.4	23	= 1089.6	40	= 1155.4

Extending the probe cable length

You can extend the cable to greater than 100 meters with no loss of signal. Atlas Scientific has tested up to 300 meters without a problem, however you run the risk of turning your temperature probe into an antennae, picking up noise along the length of your cable.

If you want to extend your cable, we recommend that you use proper isolation, such as the **Basic EZO™ Inline Voltage Isolator**, or **Tentacle Shield**. Be sure to calibrate your probe with the extended cable.

Extending a probe cable can be easily done with our **SMA Extension Cable**. Simply connect the SMA end of the probe to the Extension cable, and you are all set.

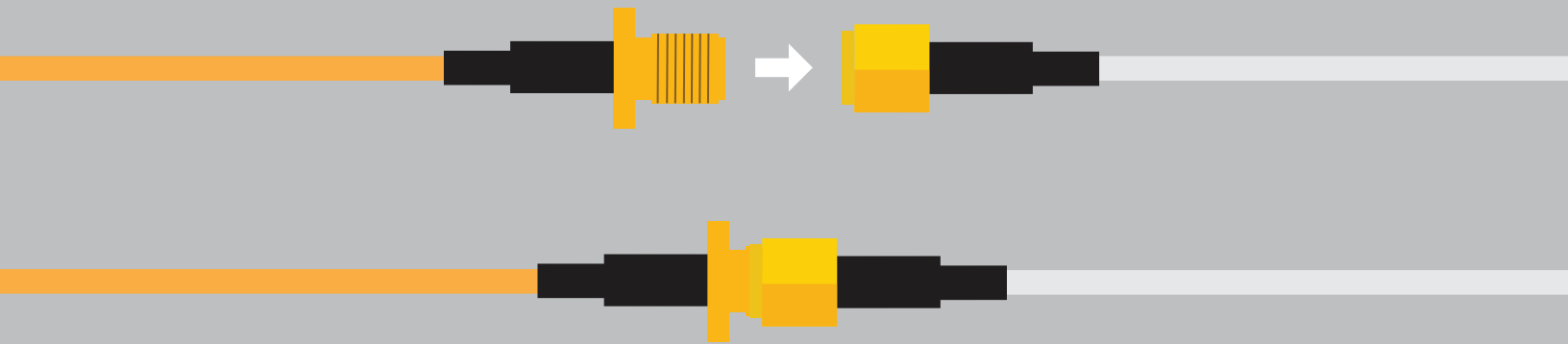

If you need to water proof a SMA connection, we highly recommend using a product like **Coax-Seal** to safely cover and prevent any water damage that may occur.

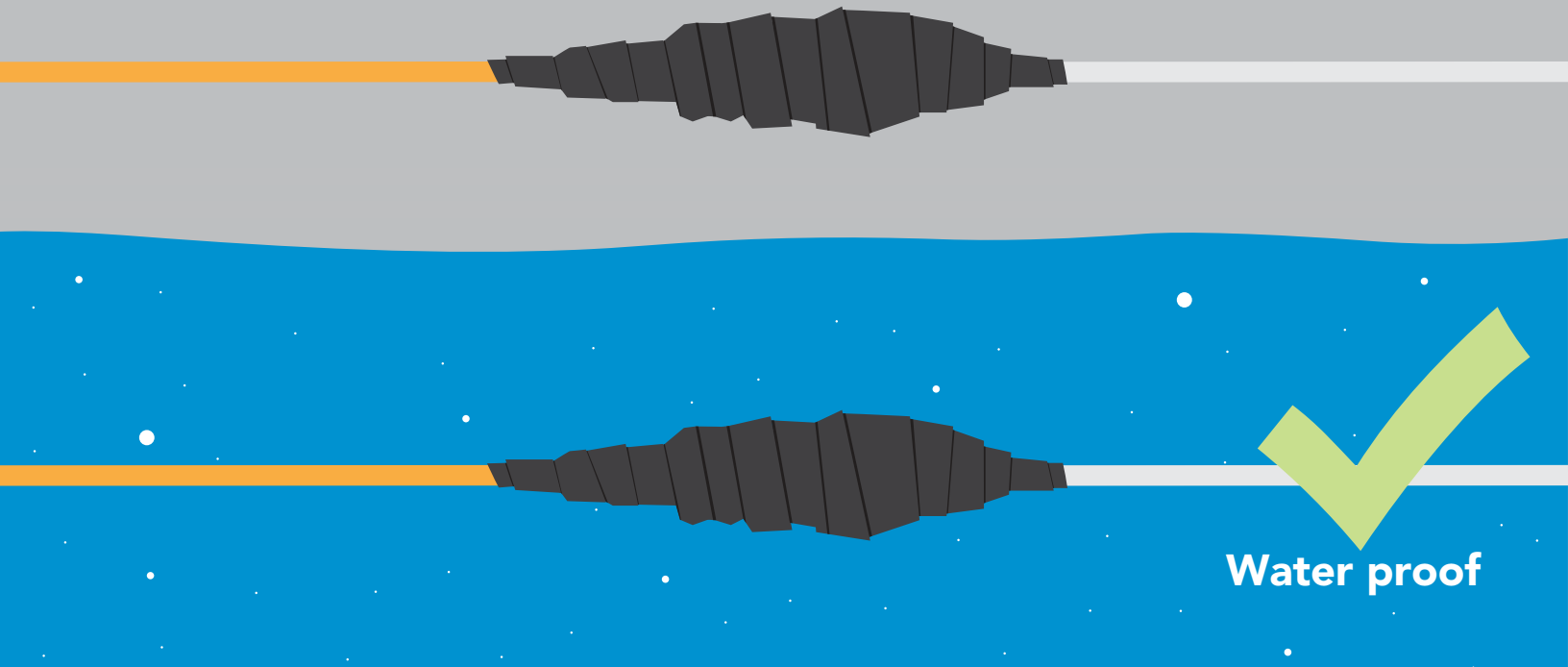

Probe cleaning

Over time the Spike Tip Temperature Probe can become dirty and covered in deposits. Both soft and hard coatings can be removed by lightly brushing around the sensing area.

